

Compact

ELECTRIC
LITHIUM
DIESEL



Snow tank volume

1.8 m³ / compacted 2.25 m³
(63.6 ft³ / compacted 79.5 ft³)



Water tank volume

600 l (158.5 gal)



Blade width

1,700 mm (66 7/8 in)



Fields of operation

Mobile / Event



elmiVome 24h shopping

BIÈRE
BEER

rothoblaas rothoblaas

KAROS
MORAN

FLA
AUGEN
K

THE CHAMPION FOR YOUR EVENT

Whether it's a sporting event or ice skating at the Christmas market: The WM Compact is the compact professional ice resurfer of choice for smaller ice rinks and large mobile ice rinks. Fitted with powerful diesel engine drive, it is suitable for use outdoors, while the electric model with emission-free AC motor is suitable for indoor use. The WM Compact resurfaces ice as well as any large professional machine, guaranteeing outstanding ice quality on smaller areas of up to 1,200 m² (12,912 ft²).



HIGHLIGHT

PROFESSIONAL QUALITY ICE RESURFACING

The robust WM Compact is easy to operate and provides outstanding comfort for the driver. With its tried and tested planing system, snow-breaker and integrated side brushes, the WM Compact guarantees perfect, professional ice resurfacing. The result? Outstanding ice even on smaller, mobile ice rink surfaces, and skating at its absolute best!





PRIMO
SISTEMA
VERBALE

ICE RESURFACING



Planing system

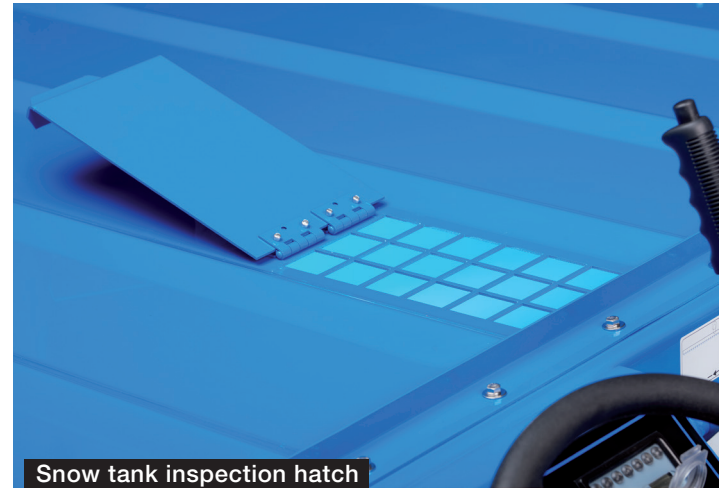

Snow tank inspection hatch



Brush



Snow tank open

The WM Compact planes the ice like a large-scale pro! The hydraulic brushes ensure perfectly smooth edges. The coated snow tank can be removed easily.

- 600 LITRES (158.5 GALLONS) WATER** +
- OUTSTANDING PLANING PERFORMANCE** +
- EASE OF REMOVAL** +

SERVICE & MAINTENANCE

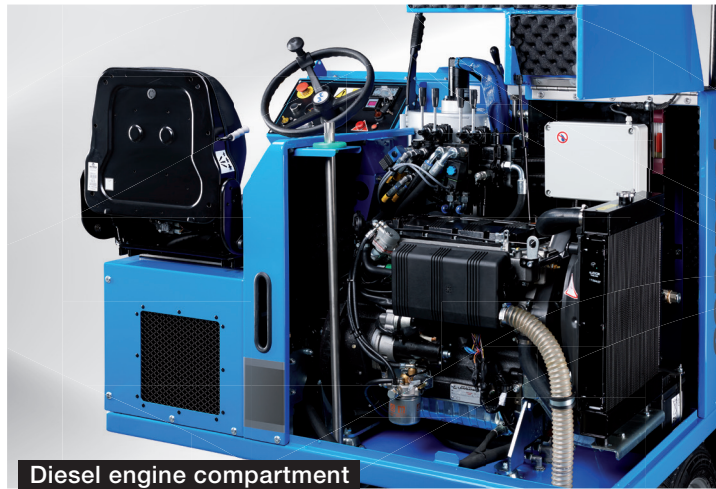

Diesel engine compartment



Saves time: Battery watering system

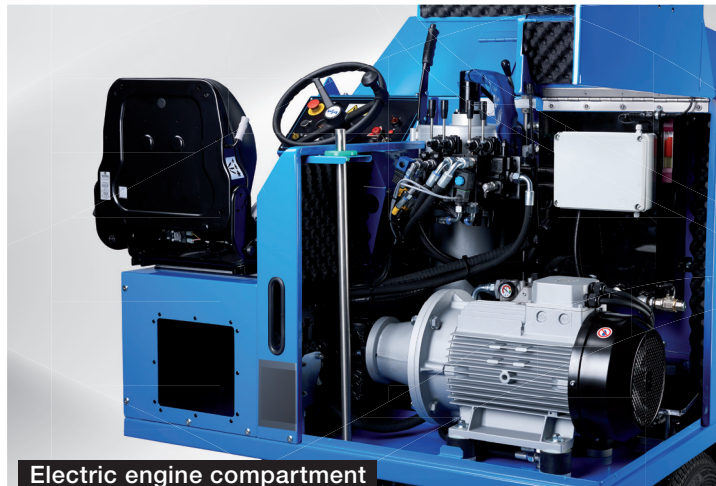

Electric engine compartment



Ease of battery replacement

The engine area is easily accessible, with no dismantling required. Maintenance is quick and inexpensive. The long-life Fronius battery charging system guarantees high energy efficiency and low operating costs.

EASILY AND QUICKLY ACCESSIBLE +

LOW MAINTENANCE COSTS +

ENERGY EFFICIENT +

ELECTRIC / LITHIUM



INCLUDED IN DELIVERY



2 blades in transport sheath



2 towels



2 rubber mats



6-mm hexagon socket T wrench



Multi-purpose key



Set hexagonal socket screws



Bodywork key



Laceration-proof safety gloves



Grindstone



Storz coupling D
ø 25 mm (ø 1 in)



Fuse set



Operating instructions

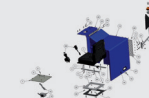

Online spare parts catalogue

FACTS & FIGURES

Motor	Asynchronous motor
Drive power	15 kW
AC motor controller	AC Curtis
Idle revolutions	900 rpm
Drive revolutions	1,900 rpm
Transmission	continuously adjustable hydraulic four-wheel drive
Speed	0 - 12 km/h (0 - 7.5 mph)
Snow tank	1.7 m ³ (60 ft ³) – compacted 2.1 m ³ (74.2 ft ³)
Water tank	600 l (158.5 gal) stainless steel
Tyres	175 / 70 R 14C 2 rows of spikes

STANDARD EQUIPMENT

Snow breaker
Hydraulically driven and swivelling side brush
Parking brake
Board guide pulley
Side mirror, rear
Side headlight
Flashing warning light
Audible signal for reverse drive
Maintenance-free asynchronous motor
Indicators on the drivers station: water tank level, battery state of charge, current consumption, status motor controller
Coated snow bin
PLC control
Spring-suspended driver's seat
Easily accessible engine compartment (tiltable bonnet)
2 blades
2 towels
Scope of delivery set



Snow tank volume

1.7 m³ / compacted 2.1 m³
(60 ft³ / compacted 74.2 ft³)



Water tank volume

600 l (158.5 gal)



Blade width

1,700 mm (66 7/8 in)



Fields of operation

Mobile / Event

DIESEL



INCLUDED IN DELIVERY



2 blades in transport sheath



2 towels



2 rubber mats

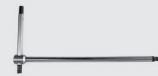

6-mm hexagon socket T wrench



Multi-purpose key



Set hexagonal socket screws



Bodywork key



Laceration-proof safety gloves



Grindstone



Storz coupling D
ø 25 mm (ø 1 in)



Fuse set



Operating instructions

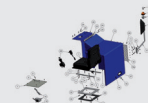

Online spare parts catalogue

FACTS & FIGURES

Engine	Kohler KDW 1404, 4 cylinders 1,372 cm ³ (84 in.cu)
Power	25.60 HP (18.80 kW) - 2,700 rpm
Torque	66.50 Nm (49 lb-ft) - 2,000 rpm
Operating torque	2,600 rpm
Fuel tank	27 l (7.1 gal) diesel
Transmission	continuously adjustable hydraulic four-wheel drive
Speed	0 - 12 km/h (0 - 7.5 mph)
Snow tank	1.8 m ³ (63.6 ft ³) – compacted 2.25 m ³ (79.5 ft ³)
Water tank	600 l (158.5 gal) stainless steel
Weight	1,650 kg (3,637 lbs)
Tyres	175 / 70 R 14C 2 rows of spikes

STANDARD EQUIPMENT

Snow breaker
Hydraulically driven and swivelling side brush
Parking brake
Board guide pulley
Hydraulic oil cooler
Side mirror, rear
Side headlight
Flashing warning light
Audible signal for reverse drive
Indicators on the drivers station: water tank level, fuel tank level, engine rpm with control lamps
Coated snow bin
PLC control
Spring-suspended driver's seat
Easily accessible engine compartment (tiltable bonnet)
2 blades
2 towels
Scope of delivery set



Snow tank volume

1.8 m³ / compacted 2.25 m³
(63.6 ft³ / compacted 79.5 ft³)



Water tank volume

600 l (158.5 gal)



Blade width

1,700 mm (66 7/8 in.)



Fields of operation

Mobile / Event

OPTIONALS

Suction system

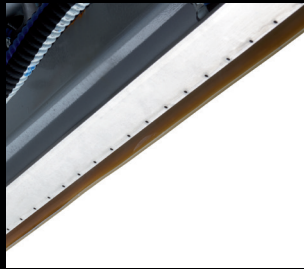

Suction manifold

Wash system



Screw conveyor wash system vertical

Overview & security



Side mirror front left



Side mirror front right

Comfort



Driver's seat with heated seat
Seat pad



Acquastop valve with time relay

Lighting



Front headlights

Personalization



Custom colour body
Paint, 1 RAL colour



Painting frame & planing unit
Paint, 1 RAL colour



Wrapping

Service



Battery trolley



Battery water filling system
for lead-acid-battery



Spare wheel 14"



Cross-key



Lifting jack with bar 3t



Tool kit



Diagnostic cables
Controller



Diagnostic cable
BMS



Access BMU
Battery-Monitoring-Unit

Accessories

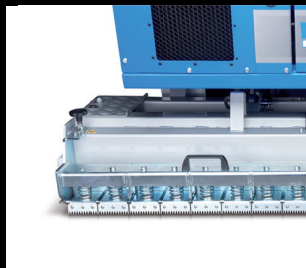

Groove-harrow
for Bavarian Curling

DIMENSIONS

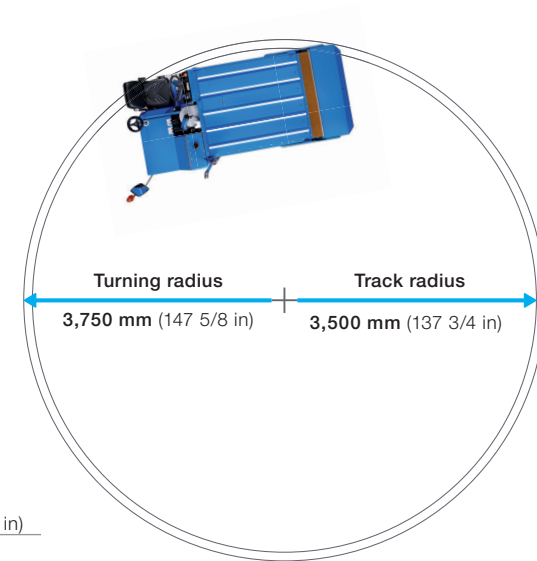
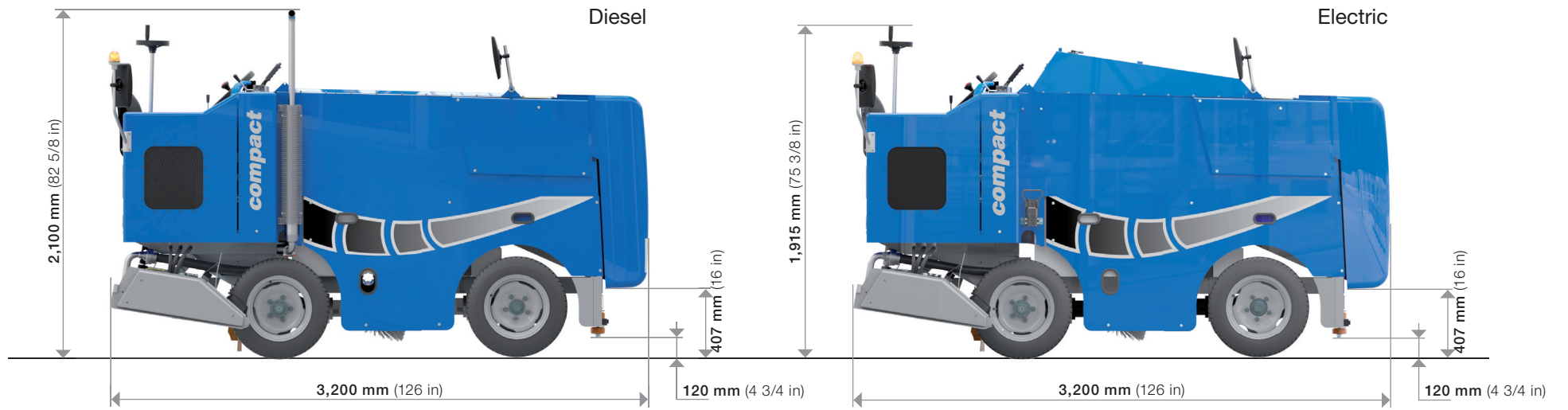



WM COMPACT DIESEL





OUR COMMITMENT

User friendliness

Through the use of top-quality components together with a well-planned design, maintenance work is extremely simple and is reduced to a minimum.



Quality guarantee

The WM Compact is a product which has been developed, built and assembled in house, from start to finish. Only by doing so can we guarantee top quality and punctual delivery times.



Detailed operating instructions

You can find all information on operation, maintenance and safety in the operating manual.

The right replacement part, every time

Order your spare parts easily and conveniently from our online portal *Blue Shop*: Our series number and digital image system enable you to find the part you need with just one click.

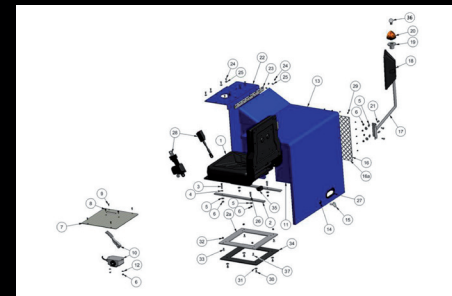

Service and support

Our well-networked, international team of technicians undergo constant training and will be delighted to help you whenever you require assistance.



Series production

All WM ice technics vehicles are series-manufactured. We know exactly which parts have been used in each series run, and can deliver the correct spare parts to you at all times. At the same time, a number of optionals can be retrofitted with minimum effort and maximum precision, even years later.

Quality consciousness

From the manufacture of individual parts right through to the final quality-control inspection: Every step of the process is carried out and monitored with the utmost of precision. Each and every member of our staff is well-trained in his specialist field, and carries out all tasks conscientiously. This is a great advantage for our customers, who can be sure of receiving a technologically sophisticated product which has been manufactured to the very highest of quality standards.





www.wm-on-ice.com
Italy

WM ice technics relies on the following distribution partners in North America:



Autoworq
Montreal (Québec)
Phone 1-866-973-1333
www.autoworq.com



LSK Enterprises
Virginia Beach (VA)
Phone 1-757-366-0166
www.lskenterprises.com



Outdooricerinks.com
Strongsville (OH)
Phone 1-440-628-7979
www.outdooricerinks.com



Mobile / Event



Pro / Heavy duty



Compact



evo